

CANTONI
MOTOR



ISO 9001

www.cantonigroup.com

SERVICE INSTRUCTION MANUAL FOR SQUIRREL - CAGE INDUCTION

MOTOR TYPE

S(K,L)g 56÷80 A,B

S(K,L)h 56÷80 A,B

(3)SIE(K,L) 80-2A,4B

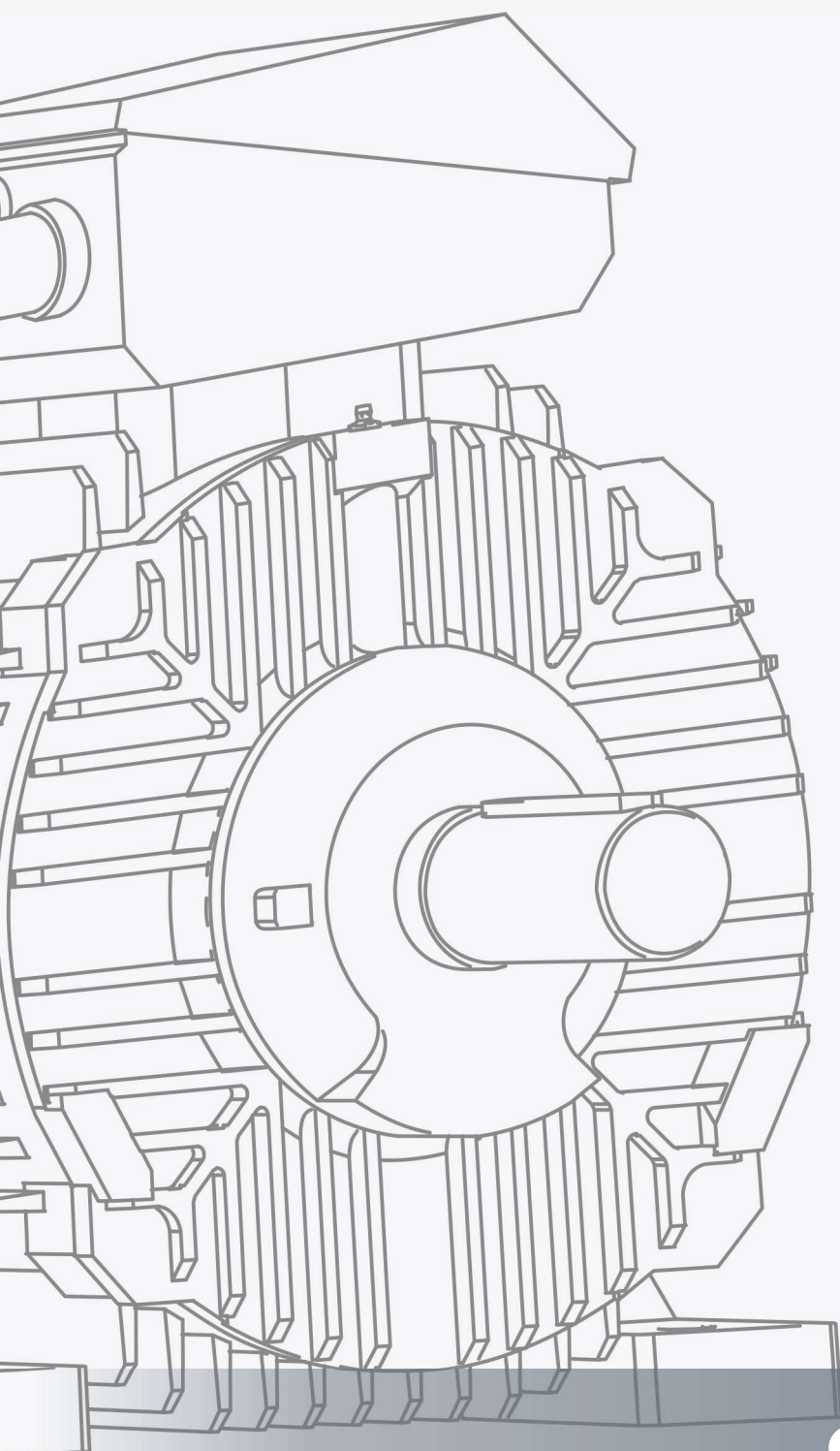

Cantoni®
GROUP

OPERATING MANUAL

OPERATING MANUAL

FOR SQUIRREL - CAGE INDUCTION MOTORS SERIES "G" AND "H",
THREE-PHASE,
SINGLE-PHASE WITH RUN CAPACITOR,
GENERAL ,
OF FRAME SIZE 56, 63, 71, 80, 90
ACCORDING TO REQUIREMENTS OF
PN-EN 60034-1
EQV IEC 60034-1



1. TECHNICAL DESCRIPTION

The squirrel-cage induction motors of frame size 56, 63, 71, 80, 90 are low power, enclosed motors. In standard execution they are in IP 54 degree of protection or IP 55 (on special request IP 56, IP 65 or IP 66). They are intended for continuous running S1 (other type of running - according to arrangements). Parts of motor housing are made of aluminum alloy EN AC-44300 (AK 11) apart from the fan cover which is made of steel sheet.

In the terminal box there is a terminal board which is used for connecting the motor to the mains and the neutral terminal PE which is used for connecting the protective conductor "PE" or protective-neutral conductor "PEN" which is indispensable in protection by automatic disconnection of supply in systems TN, TT, IT.

The terminal box is equipped with a gland M20x1,5 through which the power lead should be inserted and sealed. In single-phase motors the permanent capacitor made of metalized paper is connected in series with winding of auxiliary phase. It is also connected to terminals of the terminal board.

Motors are intended to work in a horizontal position of the shaft. They can work in perpendicular position, with the shaft end downwards or upwards provided the axial load of the bearings is not too large and originates from the weight of a rotor, a pulley or toothed wheel, relatively light clutch or the fan which is fixed on the motor shaft. Maximal radial and axial forces which can act on the shaft end - on request.

If motors are equipped with drain holes then condensation water should be drained in a horizontal position - after removing a rubber stopper.

Motors are equipped with the self-cooling.

Maximal temperature of the environment, in which the motors operate, depends on the climatic execution and cannot be higher than:

- 313K (+ 40°C) for the temperate climate N/2, N/3 and the tropical humid climate TH/2, TH/3,
- 318K (+ 45°C) for the marine climate MU/2 and MU/3.

2. OPERATING CONDITIONS

Squirrel cage induction motors series „g” and „h” frame size 56, 63, 71, 80, 90 are general destination products provided for driving various machines and devices.

The motor housing, made in the degree of protection IP 54 (or IP 55, IP 56, IP 65, IP 66) protects the motor from being penetrated by a solid body or water in the range defined in Polish Standard PN. It is recommended to use a PN-EN60034-5. Draining of condensation water should be carried out every 12 months, while exploiting under difficult conditions every 3 months.

Marine motors made according to the requirements of Polish Register of Shipping are manufactured in the minimum degree of protection IP 55. Direct-on starting is used in motors. They can operate when voltage deviations do not exceed $\pm 5\%$ of the motor rated voltage. All of the rated data refer to the rated voltage.

If voltage deviations exceed $\pm 10\%$ of the rated voltage motors should not be started.

This rule can be omitted only if motor has a suitable heat reserve for the specific application, after arrangement with BESEL S.A.

Each motor must be protected against overload and short-circuit by protections selected by an user in accordance with Polish Standard PN-89/E-05012 and recommendations of BESEL S.A..

Usage of neutral terminal depends on measure of protection against electric shock which is used in accordance with Standard HD 60364-4-41.

Parts of driven device coupled to the motor shaft directly should be balanced dynamically with an accuracy of 5 mm, not less.

2.1. Activities before the installation of a motor

Before you mount the motor to a motored device:

- a) check if the rotor turns freely,
- b) check if parts of the device which is coupled to the motor shaft are balanced dynamically with the required accuracy,
- c) put on parts of a motored device sliding or pushing them lightly without exerting pressure on bearings. Otherwise you will cause damage. At the same time the motor shaft should be supported on the non-drive end stiffly so that



the pressure should not cause either damage of bearings or damage of a spring washer which cancels axial play of the rotor,

d) after fixing the motor in a device check whether there is the minimal distance (14mm) between the fan cover and other parts, whether the holes in the cover are not stopped down.

CAUTION:

Access of cooling air to the motor housing cannot be made difficult.

2.2. Connecting the motor to the mains

2.2.1. Three-phase motors:

a) made for basic voltage 230/400V can be connected:

– to the mains with line-to-line voltage: 3x 400V $\pm 5\%$ 50Hz $\pm 2\%$, when the motor winding is star connected,

– to the mains with line-to-line voltage: 3x 230V $\pm 5\%$ 50Hz $\pm 2\%$, when the motor winding is delta connected.

b) Motors made for specific voltages can be connected to the mains of rated voltage U corresponding to the voltage marked on the rating plate of the motor UN,

U=UN $\pm 5\%$, f=fN $\pm 2\%$.

Three-phase motors of frame size 80, 71 are made as:

a) single-speed with the pole number $2p = 2, 4, 6, 8$

b) two-speed with the pole number:

$2p = 4/2$ - single-winding

$2p = 8/4$ - single-winding

$2p = 8/6$ - double-winding

$2p = 6/4$ - double-winding

and with other number of poles - as requested.

2.2.2. Single-phase motors made at voltage of 230V, 50Hz can be connected to single-phase supply network 230V $\pm 5\%$ 50Hz $\pm 2\%$

Single-phase motors with capacitor are made as single speed.

The winding and capacitor connections on the terminal board, connecting them to the mains for clockwise and anticlockwise rotation are presented on wiring diagrams on the annex No.1 of this Manual.

Wiring diagrams are on the inside of the lid of a terminal box.

Three phase and single-phase motors with a permanent capacitor made for the voltage frequency 50Hz can be connected to the mains of voltage frequency 60Hz.

Three-phase general purpose induction motors can work with frequency converter. Selection of the frequency converter and the motor depends on the motor load, speed control range, ventilation and other requirements. Range of rotation speed of standard squirrel-cage induction motors can be regulate from 10Hz to 150Hz.

2.2.3 Before you connect the motor check:

a) if the rated voltage of the motor corresponds to voltage of the mains (deviations of the voltage of the mains cannot exceed $\pm 5\%$ of the rated voltage),

b) if winding connections on the terminal board are consistent with a wiring diagram ,

c) if neutral earthing (N) and protective grounding (PE) of the motor is correct and firm,

d) if the motor has the right overload protection (thermal protection recommended),

e) if the motor has the right protection against short circuit (a fuse or an electromagnetic breaker),

f) if resistance of the motor insulation in the cool state is not lower than 20 MOhm,

g) if the direction of motor rotation is consistent with the direction of motored device rotation , in typical motors the direction is clockwise when you look from the shaft end,

h) if the capacitor (in single-phase motors) is not damaged (that is, whether the capacitor cover is not damaged or if there are not any dents).

CAUTION:

1. In case of moistening (when the resistance of the motor insulation is lower than 20 MOhm) the motor should be dried in the temperature not higher than 353K (+ 80°C).
2. Neutral earthing of the motor must be made by connecting a neutral wire to a neutral terminal of the motor (N), and protective grounding (PE) to protective terminal which is placed on the motor housing.
3. When the motor operates pay attention to how it works and disconnect the motor from the mains in following cases:
 - over-oscillation of the motor (excessive oscillation),
 - considerable decrease of rotational speed,
 - overdue heating of the motor or bearings.

3. MAINTENANCE OF THE MOTOR

The motors mentioned in position 1, 2 and 3 in Declaration of Conformity CE No. B should be subjected to periodical inspection and maintenance after 24 months of operation or after 20 000 hours of operation and special - purpose motors mentioned in position

4 and 5 in Declaration of Conformity CE No. B should be subjected to periodical inspection and maintenance after 12 months of operation or after 20 000 hours of operation.

During the inspection the following actions should be carried out:

- visual inspection (the state of seals, screw joints, surface) as well as cleaning of the motor and protecting apparatus without disassembly, to the extent that the visual inspection does not reveal such necessity,
- measurement of the resistance of motor winding insulation,
- measurement of the effectiveness of neutral earthing or the resistance of protective grounding,
- measurement of the resistance of feed installation insulation, estimation of the noise level, motor smoothness,
- draining of condensation water by unplugging the rubber plug from a drain hole
 - in IP 55 execution it is situated in drive end bearing shield;
 - in IP 56, IP 65, IP 66 execution it is situated in both bearing shields: DE and NDE

All the activities connected with disassembly, repair or assembly of the motor should be carried out by appropriately trained person, in case of electric strength test of the motor – by authorized person.

4. ACCEPTANCE TEST AFTER INSPECTION OR REPAIR

After inspection and remounting the motor should be subjected to examinations:

- a) to measure winding resistance,
- b) to control if the connections are correct,
- c) to measure insulation resistance in cool state,
- d) to carry out a 2 hours' no-load running test of the motor and if it is possible to carry out a test of a rated loaded motor. The test must be long enough for the motor temperature to stop rising in a visible way.

The above researches must be conducted according to the EN 60043-1.

5. MOTOR WEIGHTS

Motor weights are different for different types of the same frame sizes according to output, different mounting systems and other added specific details.

The table below contains maximal (approximate) motor weights as function of stacking length (A, B, C, D, S, L, M).

Frame Size of Motors	Motors									
	3 - Phase					1 - Phase				
	A	B	C (S*)	D (L*)	M	A	B	C (S*)	D (L*)	M
56	3,0	3,4	4,0	-	-	3,1	3,5	4,0	-	-
63	3,6	4,2	5,1	-	-	4,0	4,6	5,4	-	-
71	5,0	6,0	7,6	8,3	-	5,3	6,5	8,1	8,6	-
80	7,8	9,1	11,6	13,3	-	8,6	10,6	12,2	15,2	-
90	-	-	12,8	15,7	17,5	-	-	12,8	15,5	18,5

* letters S and L concern the motors in frame size 90.

6. STORAGE

Motors should be stored in dry airy containers free from gases, liquids and casting vapours which are harmful for the winding insulation and parts of the motor.

Motors must not be kept in rooms where fertilizers, chlorinated lime, acids and chemical agents etc. are gathered. The temperature of the environment where motors are stored must not be lower than 278K (+ 5°C) and relative humidity must not exceed 70 %.

Motors stored more than during a warranty period should be renovated, what includes:

- a) outside cleaning of the motor,
- b) checking if bearings operate in a correct way and, if not, damaged bearings must be replaced,
- c) measurement of the winding insulation resistance (in cool state) and if it is lower than 20 MOhm motors must be dried in a temperature not higher than 353K (+80°C).

The shaft end must be protected against corrosion by the layer of corrosion preventing grease or easily removed varnish.

7. TERMS AND CONDITIONS OF WARRANTY

Di seguito i periodi di garanzia previsti, salvo accordi diversi.

a) for general – purpose asynchronous motors described in the positions from 1 to 3 in Declaration of Conformity CE No. B:

- 24 months from date of installing,
- 30 months from date of sale.

b) for special – purpose asynchronous motors described in the positions 4 and 5 in Declaration of Conformity CE No. B:

- 12 months from date of installing,
- 18 months from date of sale.

Per maggiori informazioni, cause di perdita della garanzia e istruzioni per l'utilizzo della garanzia, consultare il sito del costruttore.

Information on Disposal for Users of Waste Electrical and Electronic Equipment

This product is marked according to the European 1000VAC Directive on Waste Electrical and Electronic Equipment (2002/96/EC) and further amendments.

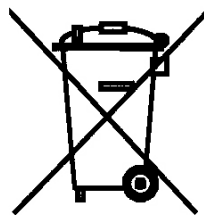

By ensuring this product is disposed of correctly, you will help to prevent potential negative consequences for the environment and human health, which could otherwise be caused by inappropriate waste handling of this product.

The symbol on the product, or the documents accompanying the product, indicates that this appliance may not be treated as household waste. It shall be handed over to the applicable collection point for used up electrical and electronic equipment for recycling purpose. For more information about recycling of this product, please contact your local authorities, your household waste disposal service or the shop where you purchased the product.

Annexes:

1. Annex No. 1 – Connection diagrams,
2. Annex No. 2 – Assembly drawing of standard motor,
3. Annex No. 3 – Declaration of Conformity No. 1/2006 (RoHS),
4. Annex No. 4 – Declaration of Conformity CE No. B

Annex n. 1

1. Three-phase single-speed induction motors type S(K,L)(g,h)..., numbers of poles:
 $2p = 2$, $2p = 4$, $2p = 6$, $2p = 8$

Delta connection

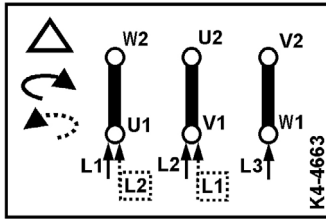

Star connection

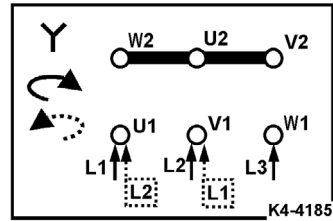

2. Three-phase induction motors with electromagnetic plate brakes of direct current:

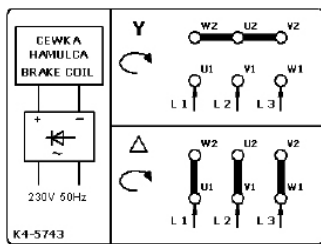

3. Three-phase two-speed induction motors type:
 – S(K,L)(g,h)..., number of poles: $2p = 4/2$ and $2p = 8/4$ (single-winding)

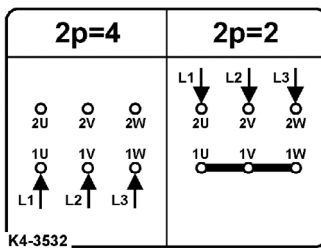

– S(K,L)(g,h)...-./..W, number of poles $2p = 4/2$ and $2p = 8/4$ (single-winding , for ventilator drive)

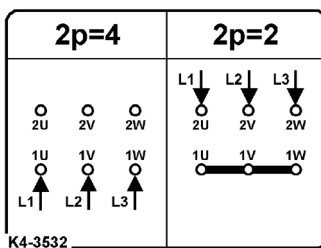

– S(K,L)(g,h)... number of poles $2p = 6/4$, $2p = 6/2$, $2p = 8/6$, $2p = 8/2$ (double-winding)

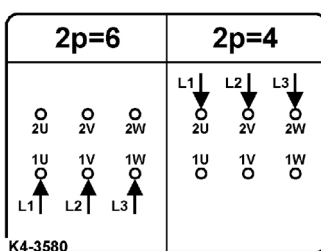

4. Single-phase induction motors type SE(M)(K,L)(g,h)... with run capacitor

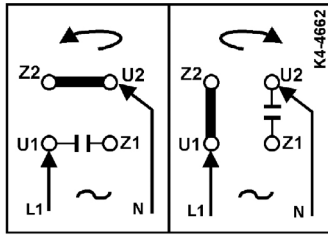

Condensatore di marcia CB

5. Single-phase induction motors type SE(M)(K,L)(g,h)...F with start capacitor, run capacitor and centrifugal switch

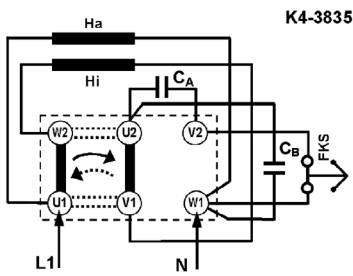

CA – start capacitor
CB – run capacitor

6. Single-phase induction reversible motors type SNM(K,L)(g,h)...

a) without temperature switch

b) with temperature switch connected in series with the winding

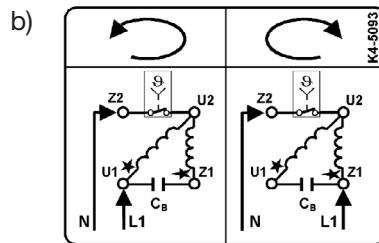
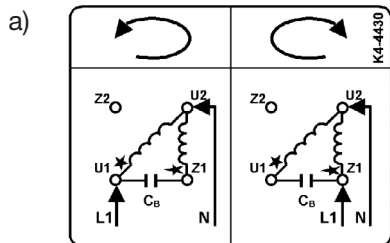

7. Single-phase induction motors with electromagnetic plate brakes of direct current:

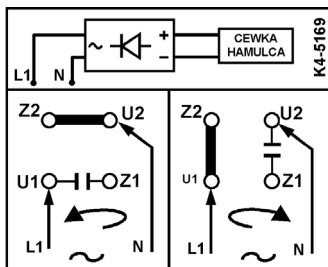

8. Single-phase induction motors type SS(K,L)(g,h)...., adapted to voltage governing of speed

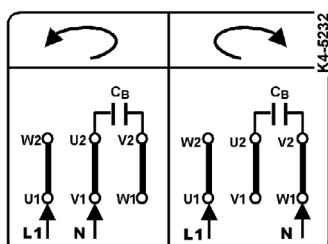

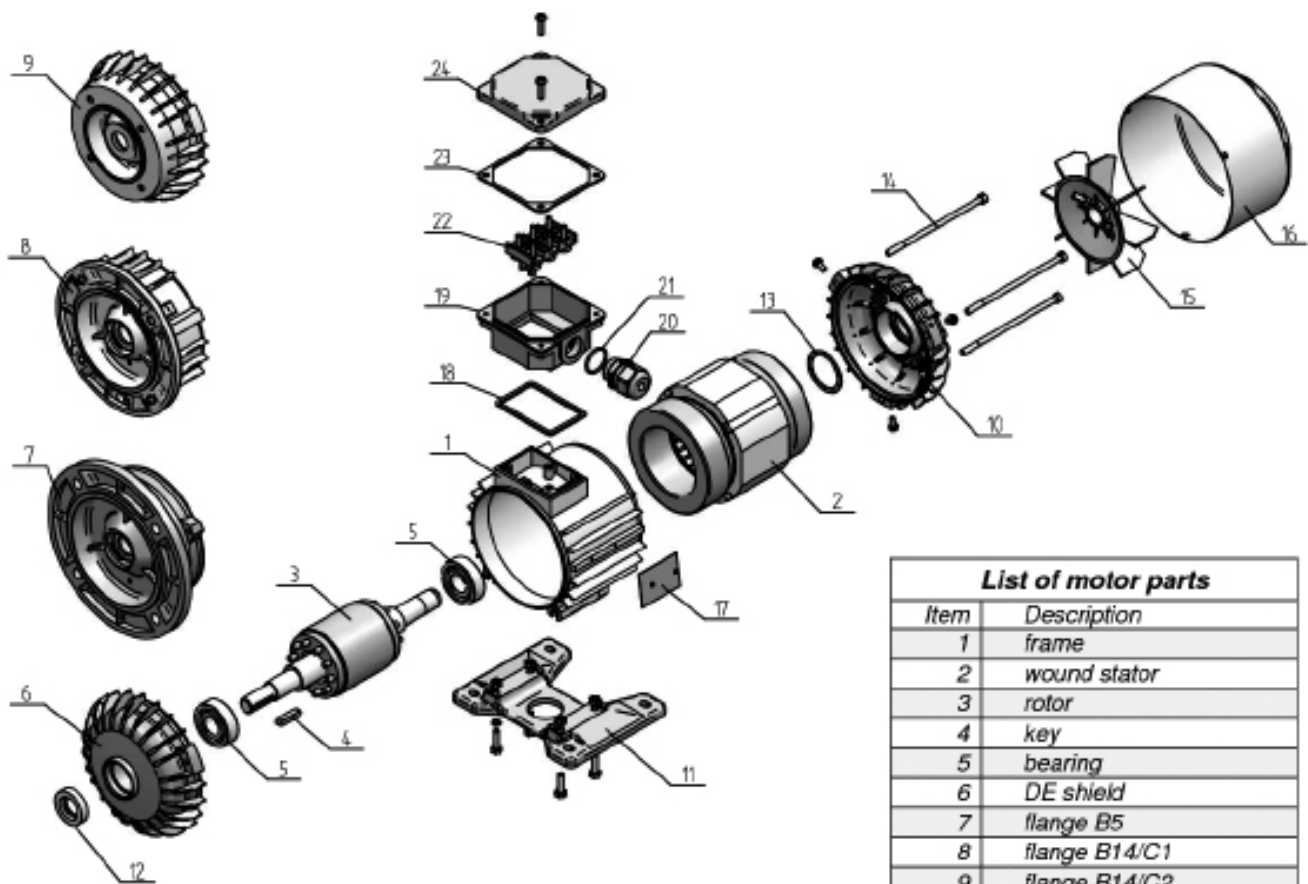

*Three phase squirrel-cage
induction motor
according to requirements of
EN 60034-1*

List of motor parts	
Item	Description
1	frame
2	wound stator
3	rotor
4	key
5	bearing
6	DE shield
7	flange B5
8	flange B14/C1
9	flange B14/C2
10	NDE shield
11	foot
12	shaft seal (IP55)
13	spring washer
14	tie rod
15	fan
16	fan cover
17	name plate
18	terminal box gasket
19	terminal box
20	cable gland
21	O-ring (IP55)
22	terminal board
23	terminal box cap gasket
24	terminal box cap



IM B3

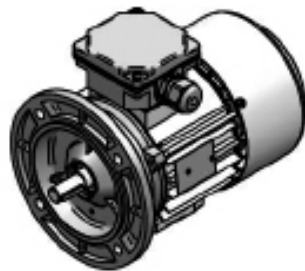

IM B5

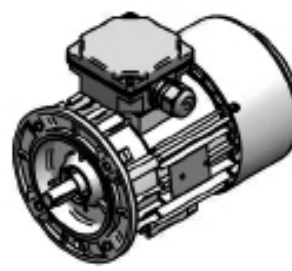

IM B14/C1

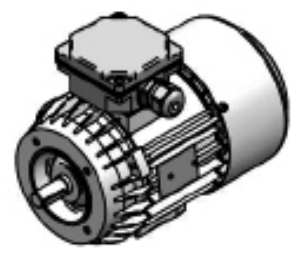

IM B14/C2

Annex n. 3

DECLARATION OF CONFORMITY with the RoHS European Directive

MANUFACTURER: FABRYKA SILNIKÓW ELEKTRYCZNYCH „BESEL” S. A.
UL. ELEKTRYCZNA 8 49-300 BRZEG
POLAND

Hereby declares with full responsibility that the products:

1. 1-phase induction motors of series:

SE(M)(K,L)g56..., SE(M)(K,L)h56..., SE(M)(K,L)g63..., SE(M)(K,L)h63..., SE(M)(K,L)hR63..., SE(K)h65..., SE(M)(K)hR65..., SE(M)(K,L)h71..., SE(M)(K,L)hR71..., SE(M)(K,L)h80..., SE(M)(K,L)hR80..., SE(M)(K,L)hZ80..., SE(M)(K,L)h90..., SE(M)(K,L)hR90..., SE(M)h100..., SE(M)h112...

2. 3-phase induction motors of series:

S(K,L)g56..., S(K,L)h56..., S(K,L)g63..., S(K,L)h63..., S(K,L)hR63..., S(K)h65..., S(K)hR65..., S(K,L)h71..., S(K,L)hR71..., S(K,L)h80..., S(K,L)hR80..., S(K,L)hZ80..., S(K,L)h90..., S(K,L)hR90...,

3. 3-phase induction, explosion-proof, increased safety motors of series:

ExS(K,L)g56, ExS(K,L)g63, ExS(K,L)h71, ExS(K,L)h80, ExS(K,L)hR71, ExS(K,L)hR80.

4. 3-phase induction motors energy efficient class IE2 and IE3:

2SIE(K,L)...

3SIE(K,L)...

5. 1-phase induction machines special-purpose, series:

SSOg..., SE(M)Og..., SE(K,L)g.../F., SE(K,L)h.../F., SE(K,L)g...HPS, SE(K,L)h...HPS, SE(K,L)g...H2SP, SE(K,L)h...H2SP, SS(K,L)g..., SS(K,L)h..., SS(K,L)hR..., SEZx..., SEK..., SN(M)(K)g..., SN(M)(K)h..., SN(M)(K)hR..., SE(M)(K,L)(g,h).../PO..

6. 3-phase induction machines special-purpose, series:

S(M)Og..., S(K,L)g...HPS, S(K,L)h...HPS, S(K,L)hR...HPS, S(K,L)g...H2SP, S(K,L)h...H2SP, S(K,L)hR...H2SP, ST(K,L)g..., RS(K,L)h..., SZx..., SK..., S(K,L)g...-.../PO., S(K,L)h...-.../PO.,

are in conformity with the following:

- 2002/95/CE Directive of the European Parliament and the Council of Europe dated on 27th January 2003 in the matter of limits of applying some dangerous substances in electrical and electronic equipment (Law Gazette WE L 37 dated on 13th February 2003) [national regulation - Minister of Economy and Labour order dated on 6th October 2004 in the matter of detailed requirements regarding limits of applying in electrical and electronic equipment some substances that could have negative influence upon environment (Law Gazette 229 position 2310 dated on 21st October 2004)];
- Decision of the European Communities Committee dated on 18-th August 2005 modifying 2002/95/CE Directive in order to establish the maximal level of concentration some dangerous substances in electrical and electronic equipment [notified as the document number C (2005) 3141] (2005/618/CE);
- Decision of the European Communities Committee dated on 13-th October 2005 modifying, in order to adapt to technological progress, the Enclosure for 2002/95/WE Directive [notified as the document number C (2005) 3754] (2005/717/CE).

Place and date of the declaration issue: Brzeg, 19th November 2012

Signed by: Andrzej Wieczorek

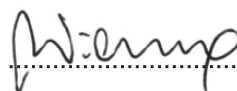

Title: Head of Design Office

Tel.: (+48 77) 416 28 61 - Fax (+48 77) 416 68 68 - e-mail: besel@cantonigroup.com

EC DECLARATION OF CONFORMITY No B
MANUFACTURER: FABRYKA SILNIKÓW ELEKTRYCZNYCH „BESEL” S.A.
 UL. ELEKTRYCZNA 8; 49-300 BRZEG
 POLSKA

I hereby declare that the products:

1. 1-phase induction motors of series:

SE(M)(K,L)g56..., SE(M)(K,L)h56..., SE(M)(K,L)g63..., SE(M)(K,L)h63..., SE(M)(K,L)hR63..., SE(K)h65..., SE(M)(K)hR65..., SE(M)(K,L)h71..., SE(M)(K,L)hR71..., SE(M)(K,L)h80..., SE(M)(K,L)hR80..., SE(M)(K,L)hZ80..., SE(M)(K,L)h90..., SE(M)(K,L)hR90..., SE(M)h100..., SE(M)h112...

2. 3-phase induction motors of series:

S(K,L)g56..., S(K,L)h56..., S(K,L)g63..., S(K,L)h63..., S(K,L)hR63..., S(K)h65..., S(K)hR65..., S(K,L)h71..., S(K,L)hR71..., S(K,L)h80..., S(K,L)hR80..., S(K,L)hZ80..., S(K,L)h90..., S(K,L)hR90...,

3. 3-phase induction motors energy efficient class IE2 and IE3:

2SIE(K,L)...

3SIE(K,L)...

4. 1-phase induction machines special-purpose, series:

SSOg..., SE(M)Og..., SE(K,L)g.../F., SE(K,L)h.../F., SE(K,L)g...HPS, SE(K,L)g...H2SP, SE(K,L)h...HPS, SE(K,L)h...H2SP, SS(K,L)g..., SS(K,L)h..., SEZx..., SEK..., SN(M)(K)g..., SN(M)(K)h..., SN(M)(K)hR..., SE(M)(K,L)(g,h)...-/PO..

5. 3-phase induction machines special-purpose, series:

S(M)Og..., S(K,L)g...HPS, S(K,L)g...H2SP, S(K,L)h...HPS, S(K,L)h...H2SP, S(K,L)hR...HPS, S(K,L)hR...H2SP, ST(K,L)g..., RS(K,L)h..., SZx..., SK..., S(K,L)g...-/PO., S(K,L)h...-/PO..

provided with CE marking of conformity complies with the provisions of Low Voltage Directive 2006/95/EC of 12.12.2006 and are in conformity with the standard **EN 60034-1:2010**

and additionally the products described in point 3 are in conformity with the “Commission Regulation (EC) No 640/2009 of 22 July 2009 implementing Directive 2005/32/EC of the European Parliament and of the Council with regard to ecodesign requirements for electric motors” and with the standard **EN 60034-30:2009**.

By design the machines, considered as components, comply with the requirements of:

- Machinery Directive 2006/42/EC
- EMC Directive 2004/108/EC.

Quality Management System fulfils the requirements of standard ISO 9001:2008, certificate DEKRA number 000612060.

Manufacturer’s statement:

The machines with installed above products should be declared in conformity with the Machinery Directive.

Place and date of the declaration issue: Brzeg, 19th November 2012

Signed by: Andrzej Wieczorek

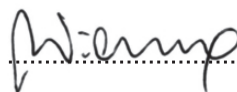

Title: Head of Design Office

CANTONI
MOTOR



CANTONI MOTOR S.A.
3 Maja 28
43-400 Cieszyn, Poland
tel.: +48 33 813 87 00
fax: +48 33 813 87 01
motor@cantonigroup.com
www.cantonigroup.com